

Article number: 54301506

Description: LDK Rod end PHS 6EC

## Measures

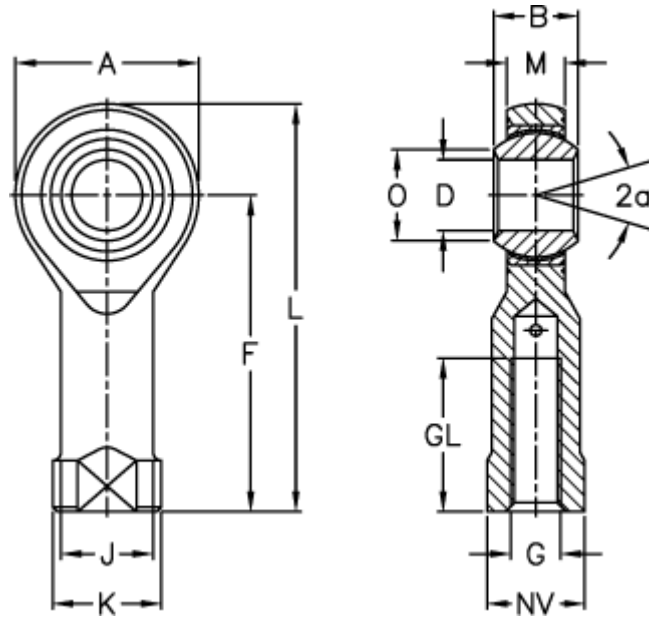

A	= 18	J	= 10.0
a (degrees)	= 13	K	= 13
B	= 9	L	= 39
D	= 6	M	= 6.75
Dynamic load C (kN)	= 4.6	NV	= 11
F	= 30	O	= 8.9
g	= M6	Static load C0 (kN)	= 8.6
GL	= 13	Weight (g)	= 25